

Warmington Gas Open Fire

SG 780 Firebox

Fire, Flue System to Comply with NZS 5261 / 5262 : 2003

Due to continued product improvement, Warmington Ind LTD reserves the right to change product specifications without prior notification.

Read all the Instructions carefully before commencing the Installation. Failure to follow these instructions may result in a fire hazard and void the warranty

For Specification See: www.warmington.co.nz

Copyright ©

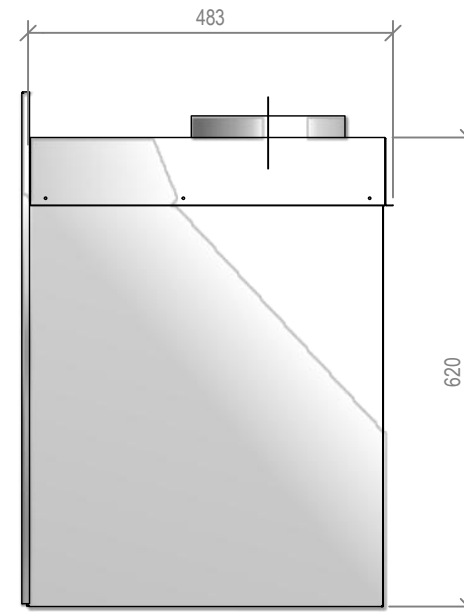

Warmington Industries Ltd.	
PH: 09 273 9227 FAX: 09 273 9241 WEB: www.warmington.co.nz	
TITLE	SG 780 FIREBOX
DRAWN	ALAN
DATE	02/05/11
SCALE	NOT TO SCALE
REVISION	01

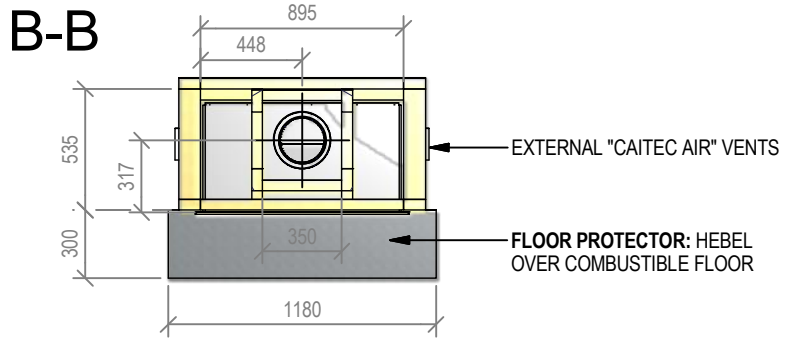

Warmington Gas Open Fire

SG 780 Timber Framing

Fire, Flue System to Comply with NZS 5261 / 5262 : 2003
Due to continued product improvement, Warmington Ind LTD reserves the right to change product specifications without prior notification.
 Read all the Instructions carefully before commencing the Installation. Failure to follow these instructions may result in a fire hazard and void the warranty
 For Specification See: www.warmington.co.nz
 Copyright ©

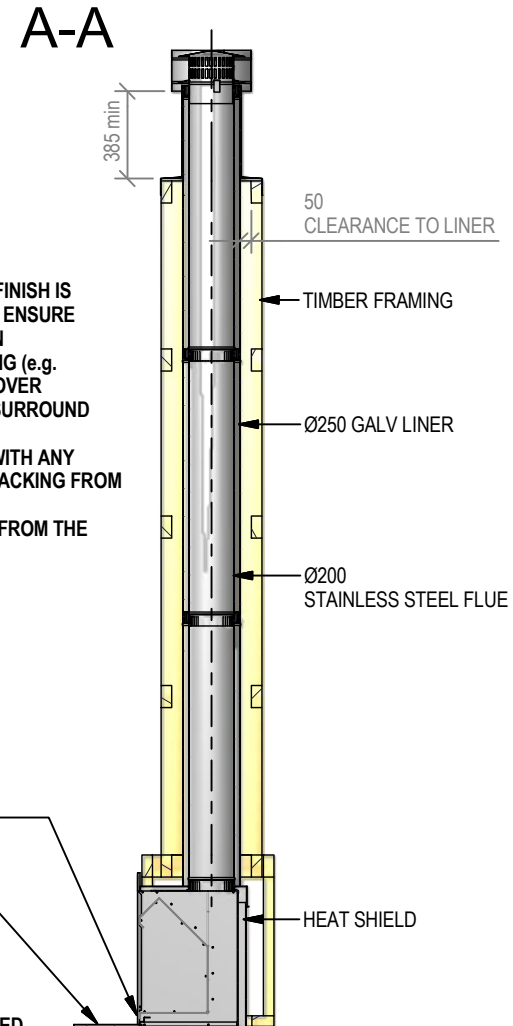
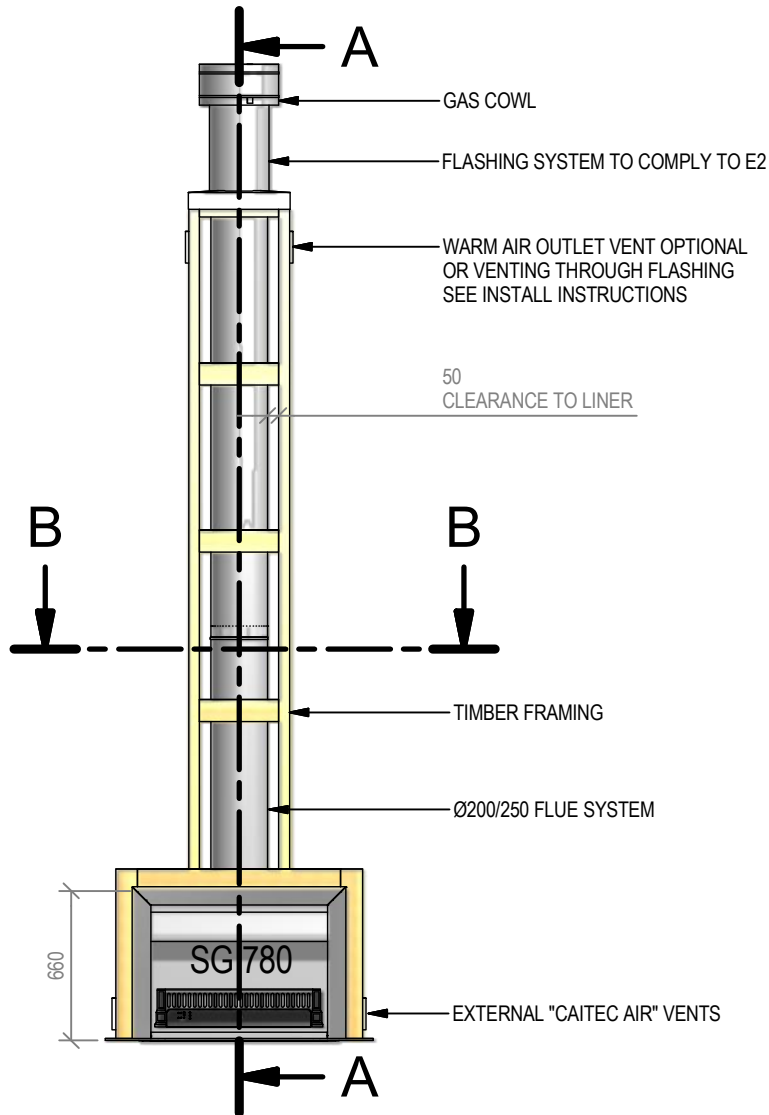

IMPORTANT NOTE:
 WHERE AN INTERNAL WALL BOARD FINISH IS REQUIRED AROUND THE FIREPLACE, ENSURE ALLOWANCE IS MADE TO PLACE NON COMBUSTIBLE INTERNAL WALL LINING (e.g. PROMINA ETERPAN, SUPALUX) TO COVER THE EXTENT OF THE HEBEL BLOCK SURROUND

DIRECTLY TOUCHING THE FIREBOX WITH ANY BOARD OR PLASTER MAY CAUSE CRACKING FROM HEAT EXPANSION
 ALLOW 3mm MINIMUM SPACE AWAY FROM THE FIREBOX

ENSURE THE LOWER AIR INTAKE IS NOT OBSTRUCTED

ALLOW FINISHING ON FLOOR PROTECTOR

NOTE:
 WARMINGTON CAITEC AIR IS REQUIRED
 SEE SPECIFIC INSTALL INSTRUCTION

Warmington Industries Ltd.			
PH: 09 273 9227 FAX: 09 273 9241 WEB: www.warmington.co.nz			
TITLE	SG 780 TIMBER FRAMING	DATE	02/05/11
DRAWN	ALAN	REVISION	01
SCALE	NOT TO SCALE		

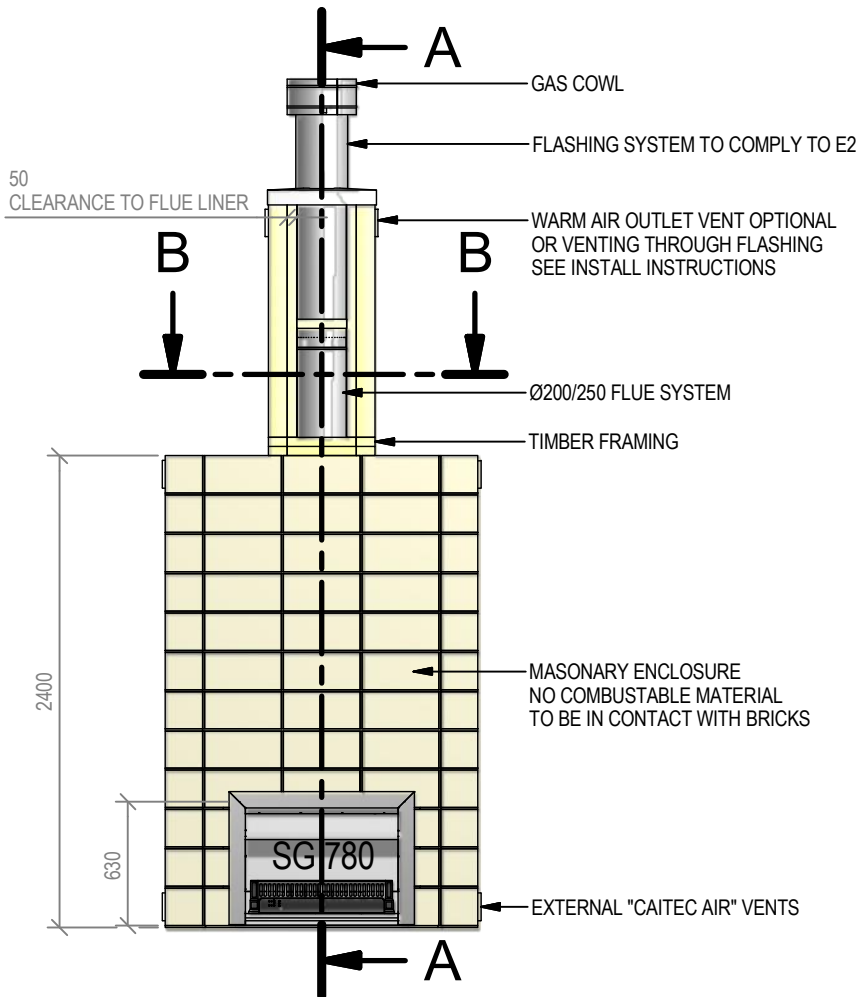
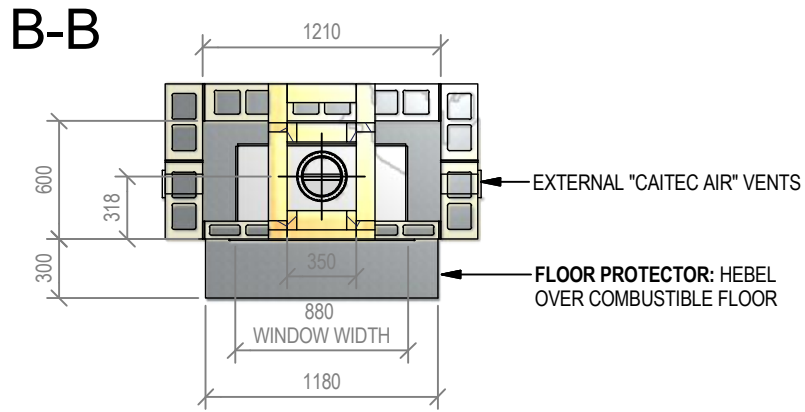

Warmington Gas Open Fire

SG 780 Block Enclosure

Fire, Flue System to Comply with NZS 5261 / 5262 : 2003

Due to continued product improvement, Warmington Ind LTD reserves the right to change product specifications without prior notification.

Read all the Instructions carefully before commencing the Installation. Failure to follow these instructions may result in a fire hazard and void the warranty

For Specification See: www.warmington.co.nz

Copyright ©

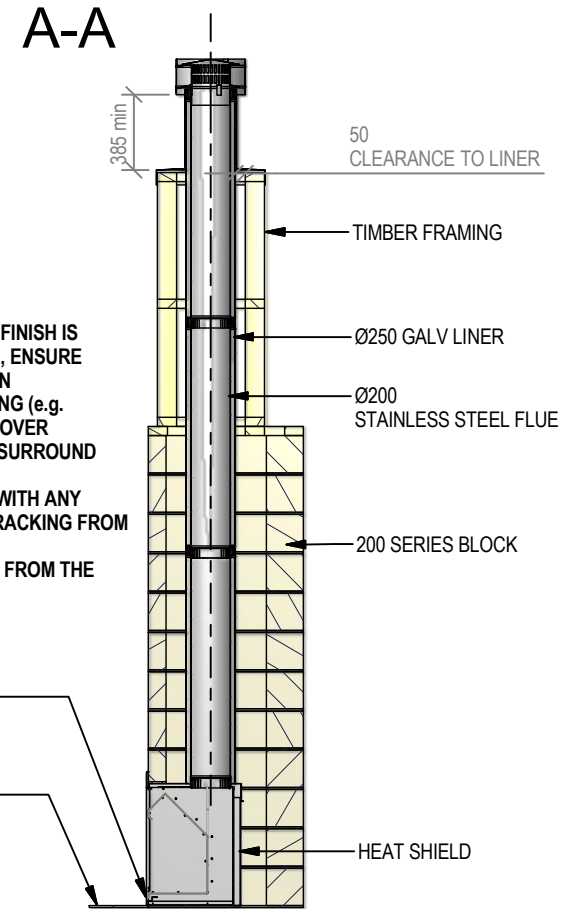

IMPORTANT NOTE:

WHERE AN INTERNAL WALL BOARD FINISH IS REQUIRED AROUND THE FIREPLACE, ENSURE ALLOWANCE IS MADE TO PLACE NON COMBUSTIBLE INTERNAL WALL LINING (e.g. PROMINA ETERPAN, SUPALUX) TO COVER THE EXTENT OF THE HEBEL BLOCK SURROUND

DIRECTLY TOUCHING THE FIREBOX WITH ANY BOARD OR PLASTER MAY CAUSE CRACKING FROM HEAT EXPANSION
ALLOW 3mm MINIMUM SPACE AWAY FROM THE FIREBOX

ENSURE THE LOWER AIR INTAKE IS NOT OBSTRUCTED

ALLOW FINISHING ON FLOOR PROTECTOR

NOTE:
WARMINGTON CAITEC AIR IS REQUIRED
SEE SPECIFIC INSTALL INSTRUCTION

Warmington Industries Ltd.			
PH: 09 273 9227 FAX: 09 273 9241 WEB: www.warmington.co.nz			
TITLE	SG 780 TBLOCK ENCLOSURE		
DRAWN	ALAN	DATE	03/05/11
SCALE	NOT TO SCALE		REVISION 01