

# Warmington Outdoor Wood Fire

## SN 1800 Pizzeria Firebox Double Flue

NOTE: Requires Hebel Enclosure

Fire, Flue System to Comply with ASNZS 2918:2001

**Due to continued product improvement, Warmington Ind LTD reserves the right to change product specifications without prior notification.**

Read all the Instructions carefully before commencing the Installation. Failure to follow these instructions may result in a fire hazard and void the warranty

For Specification See: [www.warmington.co.nz](http://www.warmington.co.nz)

Copyright ©

NOTE: Engineering calculations may be required

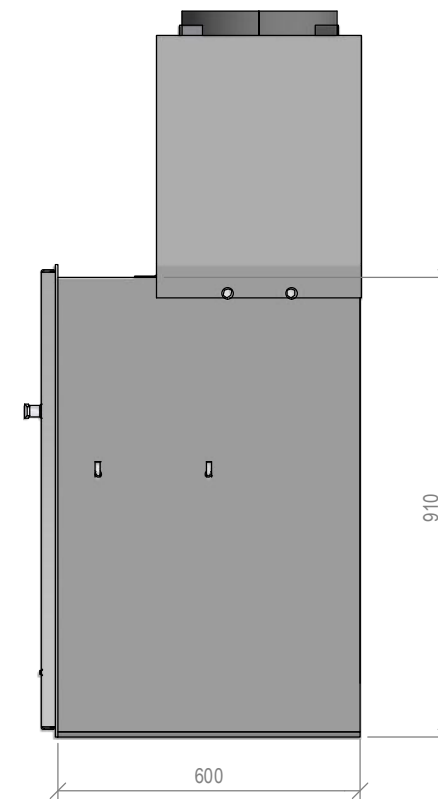
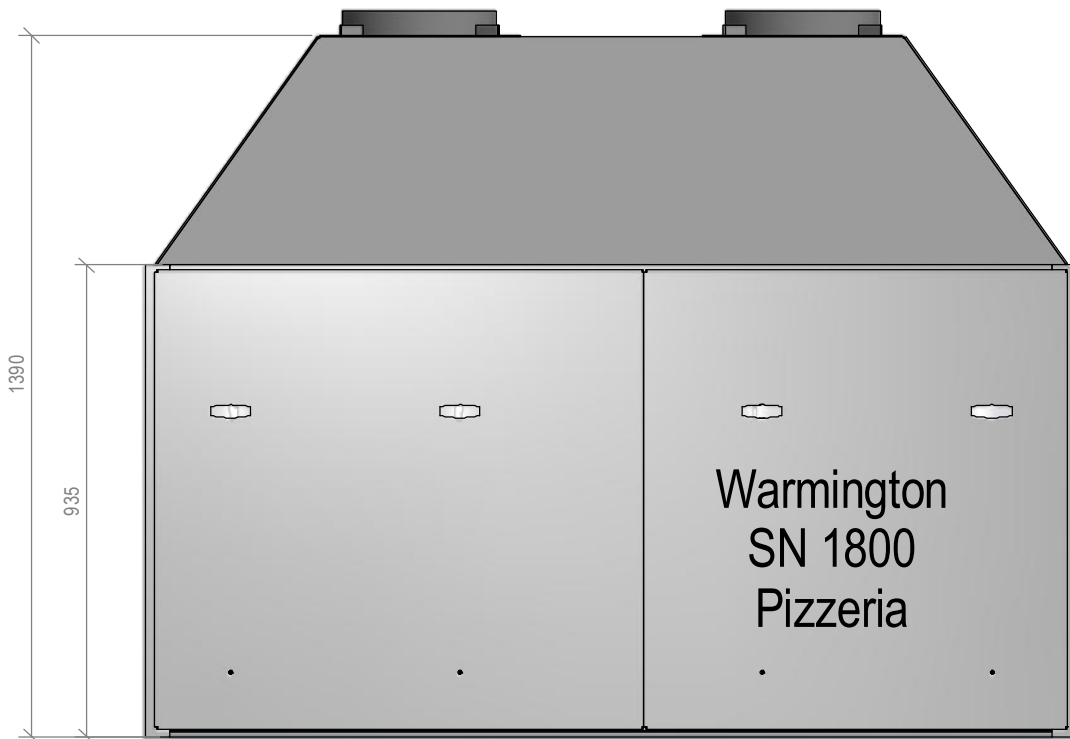

|  |                                      |          |         |
|--|--------------------------------------|----------|---------|
| <b>Warmington Industries Ltd.</b>  |                                      |          |         |
| PH: 09 273 9227 FAX: 09 273 9241 WEB: <a href="http://www.warmington.co.nz">www.warmington.co.nz</a> |                                      |          |         |
| TITLE  | SN 1800 Pizzeria DOUBLE FLUE FIREBOX |          |         |
| DRAWN  | BEN                                  | DATE     | 1/05/18 |
| SCALE  | NOT TO SCALE                         | REVISION | 03      |

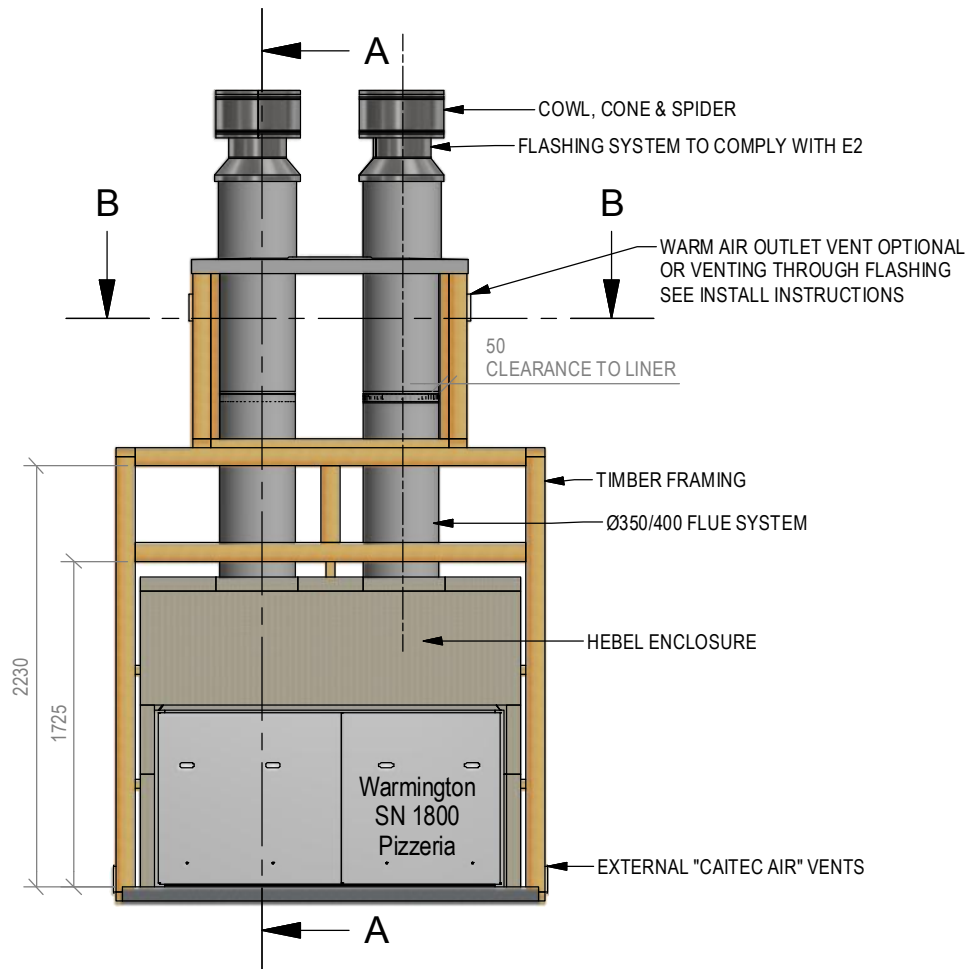
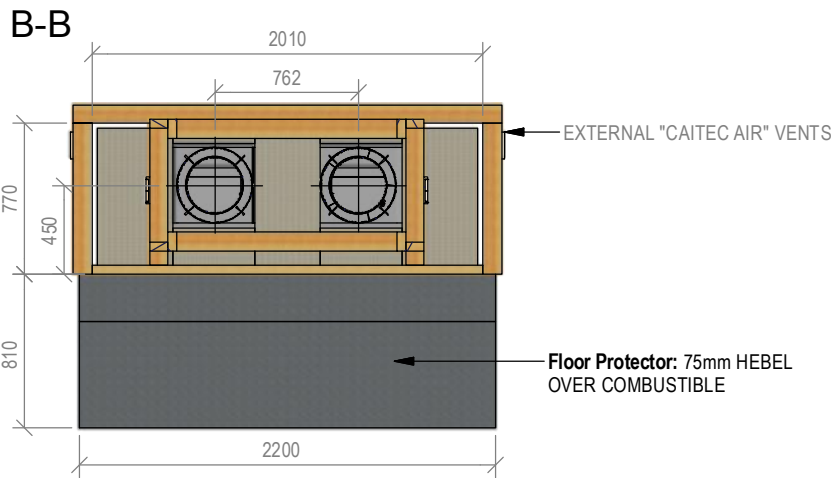

# Warmington Outdoor Wood Fire SN 1800 Pizzeria Double Flue Timber Framing

NOTE: Requires Hebel Enclosure  
Fire, Flue System to Comply with ASNZS 2918:2001

**Due to continued product improvement, Warmington Ind LTD reserves the right to change product specifications without prior notification.**

Read all the Instructions carefully before commencing the Installation. Failure to follow these instructions may result in a fire hazard and void the warranty

For Specification See: [www.warmington.co.nz](http://www.warmington.co.nz)

Copyright ©

NOTE: Engineering calculations may be required

**IMPORTANT NOTE:**

WHERE AN INTERNAL WALL BOARD FINISH IS REQUIRED AROUND THE FIREPLACE, ENSURE ALLOWANCE IS MADE TO PLACE NON COMBUSTIBLE INTERNAL WALL LINING (e.g. PROMINA ETERPAN, SUPALUX) TO COVER THE EXTENT OF THE HEBEL BLOCK SURROUND

DIRECTLY TOUCHING THE FIREBOX WITH ANY BOARD OR PLASTER MAY CAUSE CRACKING FROM HEAT EXPANSION  
ALLOW 3mm MINIMUM SPACE AWAY FROM THE FIREBOX

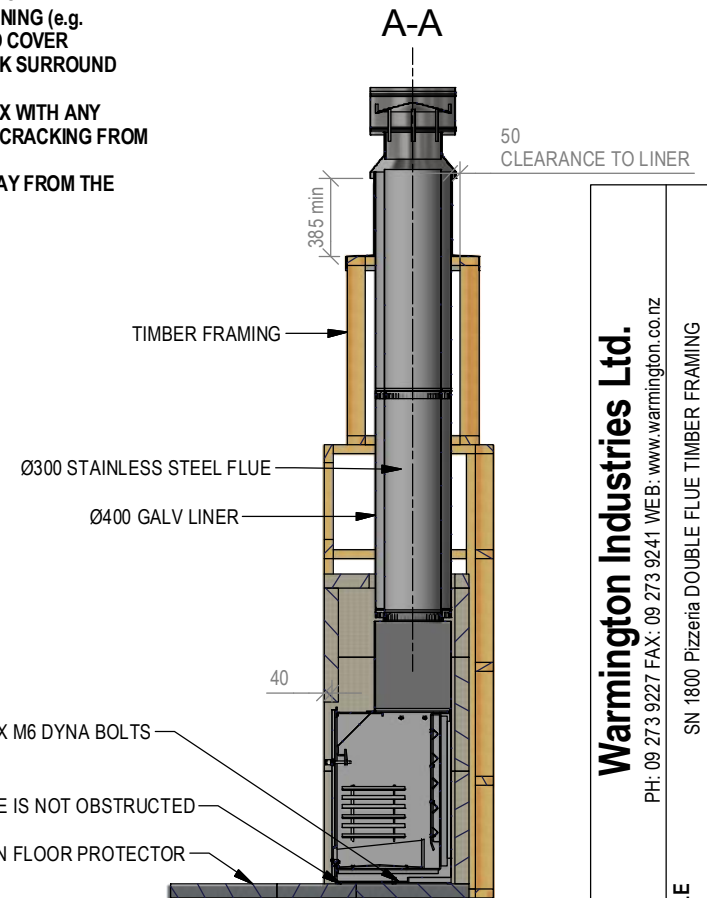

**NOTE:**  
WARMINGTON CAITEC AIR IS REQUIRED  
SEE SPECIFIC INSTALL INSTRUCTION

|  |   |          |         |
|--|---|----------|---------|
| <b>Warmington Industries Ltd.</b>  |   |          |         |
| PH: 09 273 9227 FAX: 09 273 9241 WEB: <a href="http://www.warmington.co.nz">www.warmington.co.nz</a> |   |          |         |
| TITLE  | SN 1800 Pizzeria DOUBLE FLUE TIMBER FRAMING | DATE     | 1/05/18 |
| DRAWN  | BEN   | REVISION | 03      |
| SCALE  | NOT TO SCALE                                |          |         |

B-B

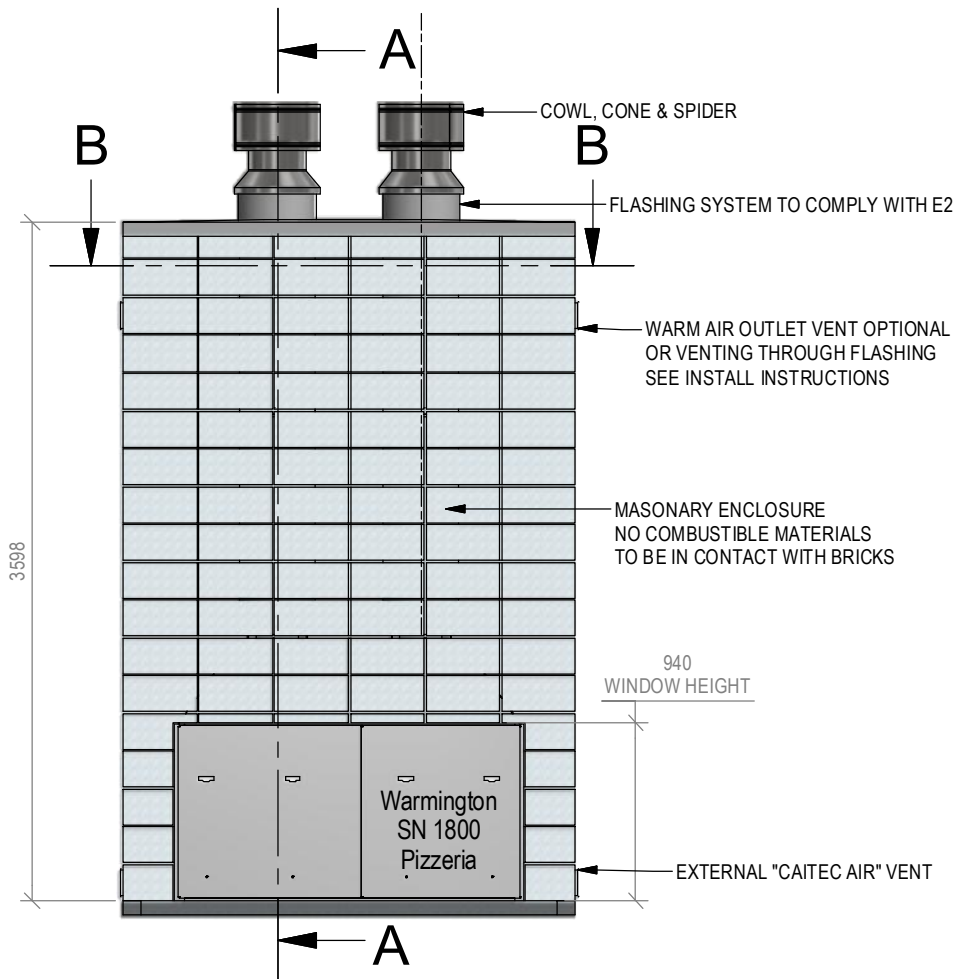
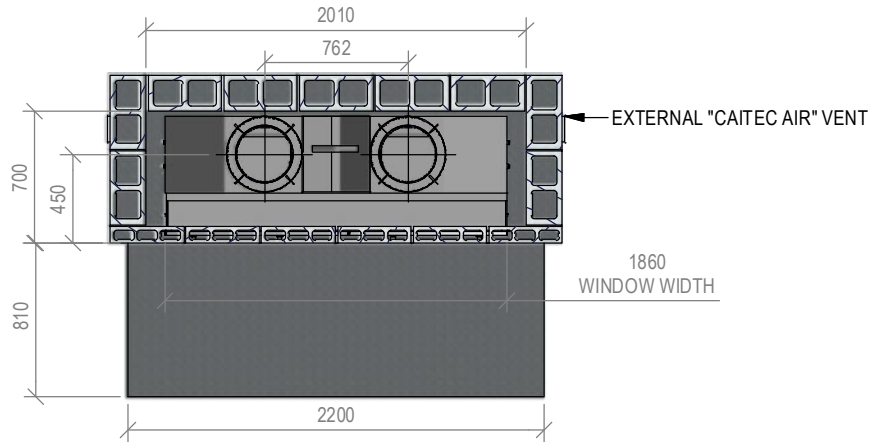

# Warmington Outdoor Wood Fire

## SN 1800 Pizzeria Double Flue Block Enclosure

Fire, Flue System to Comply with ASNZS 2918:2001

**Due to continued product improvement, Warmington Ind LTD reserves the right to change product specifications without prior notification.**

Read all the Instructions carefully before commencing the Installation. Failure to follow these instructions may result in a fire hazard and void the warranty

For Specification See: [www.warmington.co.nz](http://www.warmington.co.nz)  
Copyright ©

NOTE: Engineering calculations may be required

**IMPORTANT NOTE:**  
WHERE AN INTERNAL WALL BOARD FINISH IS REQUIRED AROUND THE FIREPLACE, ENSURE ALLOWANCE IS MADE TO PLACE NON COMBUSTIBLE INTERNAL WALL LINING (e.g. PROMINA ETERPAN, SUPALUX) TO COVER THE EXTENT OF THE HEBEL BLOCK SURROUND

DIRECTLY TOUCHING THE FIREBOX WITH ANY BOARD OR PLASTER MAY CAUSE CRACKING FROM HEAT EXPANSION  
ALLOW 3mm MINIMUM SPACE AWAY FROM THE FIREBOX

SECURE FIRE TO BASE WITH 2 X M6 DYNA BOLTS  
SEE INSTRUCTIONS

ENSURE LOWER AIR INTAKE IS NOT OBSTRUCTED

ALLOW FINISHING ON FLOOR PROTECTOR

**NOTE:**  
WARMINGTON CAITEC AIR IS REQUIRED  
SEE SPECIFIC INSTALL INSTRUCTION

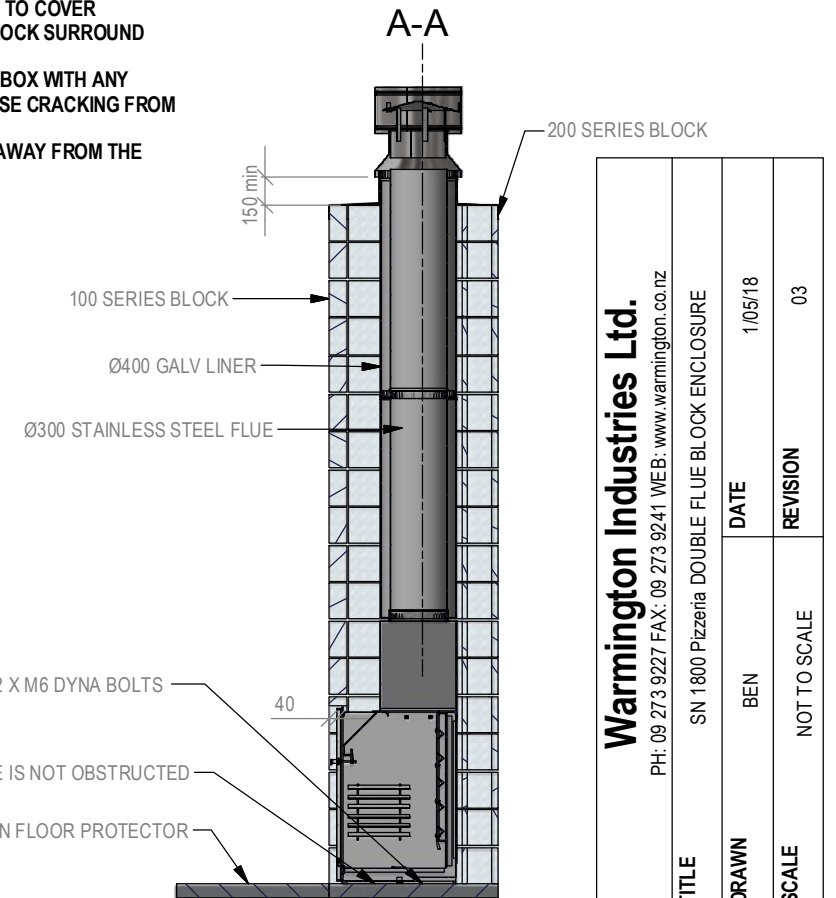

|  |  |          |         |
|--|--|----------|---------|
| <b>Warmington Industries Ltd.</b>  |  |          |         |
| PH: 09 273 9227 FAX: 09 273 9241 WEB: <a href="http://www.warmington.co.nz">www.warmington.co.nz</a> |  |          |         |
| TITLE  | SN 1800 Pizzeria DOUBLE FLUE BLOCK ENCLOSURE | DATE     | 1/05/18 |
| DRAWN  | BEN  | REVISION | 03      |
| SCALE  | NOT TO SCALE                                 |          |         |